

Absorba Table Screen



MATERIAL

Core of Ecophon 20/40 mm. Framework in birch plywood 20/40x12 mm. The table clamp can be adjusted to size and mounting on the screen is flexible in height and side according to customer requirements. Take part in Decibel's color range, 405 variants of different finishes are offered as standard. Choose from all 195 RAL colors, alternatives are available both as solid finish (gloss 72) or Structure finish which has a matte, slightly textured elegant surface. In addition, 15 RAL colors with pearl finish. Black and white are standard. For all colours see www.decibelab.com

FABRIC

The fabrics we use for our sound absorbers are all carefully selected and tested according to the current standard used by manufacturers. The absorbent has removable fabric as standard. Prices on request for other fabrics.

PG0

Camira Cara
Camira Carlow
Camira Era 170
Davis Sawana
Gabriel Event Screen
Gabriel Hush

PG1

Gabriel Soul
Gabriel Soul Solange
Gabriel Twist
Gabriel Twist Melange
Gabriel Xpress (2,0)
Kvadrat Remix Screen

STANDARD DIMENSIONS IN MM

H : 600 with W : 640 / 740 / 840 / 940 / 1200 / 1400 / 1600 / 1800
Height 600 mm (500 mm above table edge)

H : 800 with W : 640 / 740 / 840 / 940 / 1200 / 1400 / 1600 / 1800
Height 800 mm (600 mm above table edge)

D : 30 and 50 mm

*For special measurements request a quote.

OPTIONS

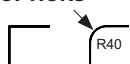

Straight or rounded top corners.

MOUNTING

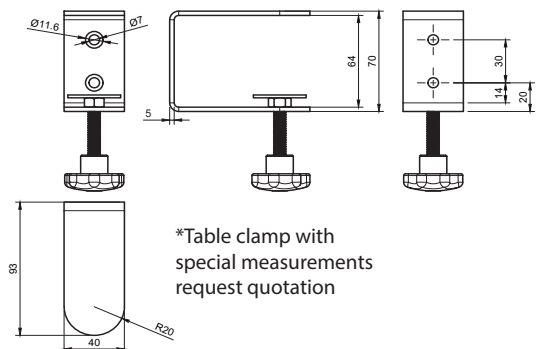
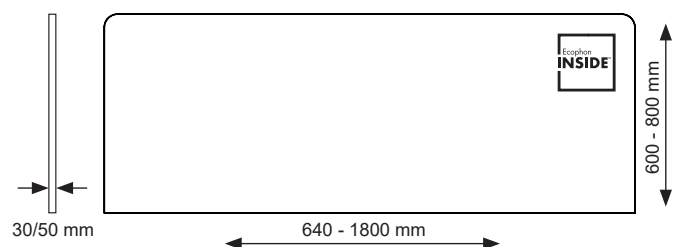
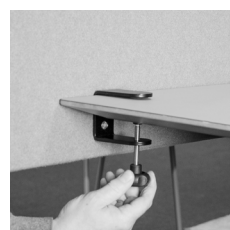
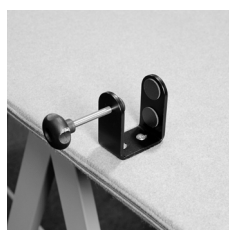
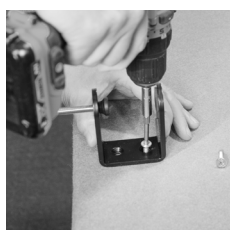
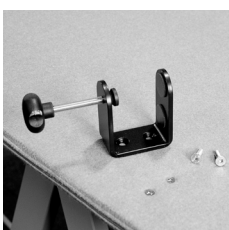

CERTIFICATE

EN 1023-2:2000
EN 1023-3:2000
EN 1023-1:1996
SS-EN ISO354:2003
ISO 20189:2018
N10 value 1800x850x30 = 6,7

